

power terminal board Roery swiech breaker 1#compressor Chilled water pump cooling fan Phase sequence protector Control circuit

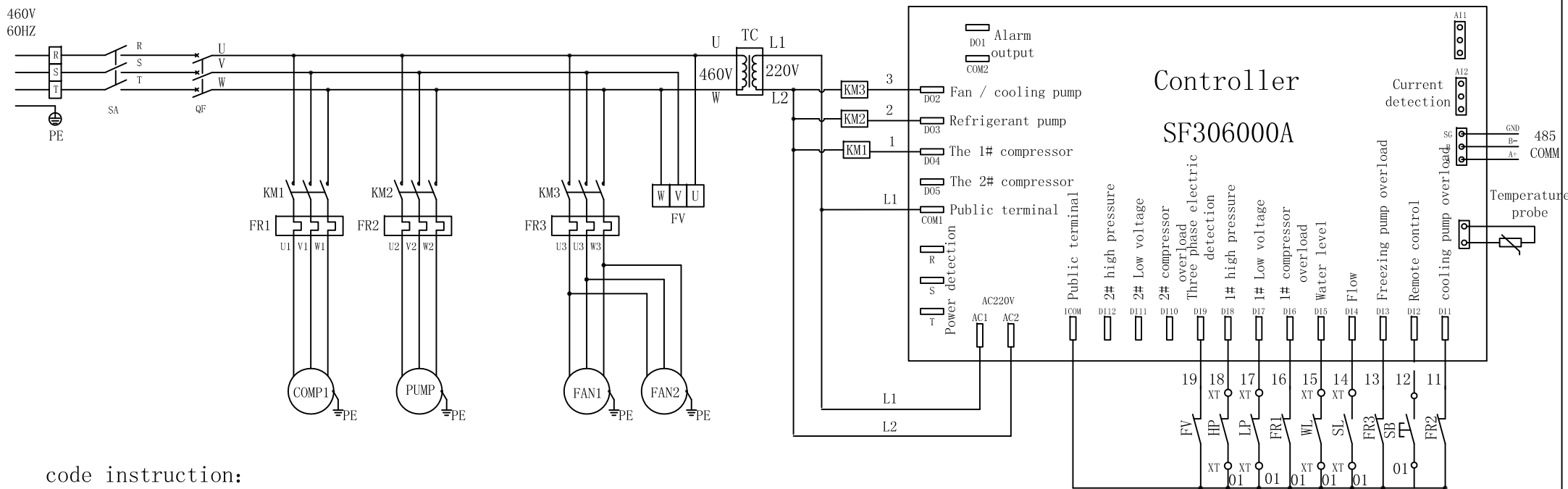

code instruction:

- QF: breaker
- KM: contactor
- SB: switch bottom
- XT: terminal board
- COM: compressor
- FAN: cooling fan
- KI: current sensor
- SA: Changeover switch
- LP: low pressure controller
- PUMP: Chilled water pump
- WL: Water level protection
- HP: high pressure controller
- FV: Phase sequence protector

Technical description:

- 1 of all electrical equipment must be well grounded.
- 2 remote control user needs can be self-contained switch

	model	HBC-5	version	A1
made	Rusonqian	date	2016.12.13	type
check		date		total
1/1 Air cooled type cooling water machine				